

<: \*, \$B

87! 87

J% \$\$

Ki \Ub ; i ] XY HYW\bc` c[m 7c" ž@hX"

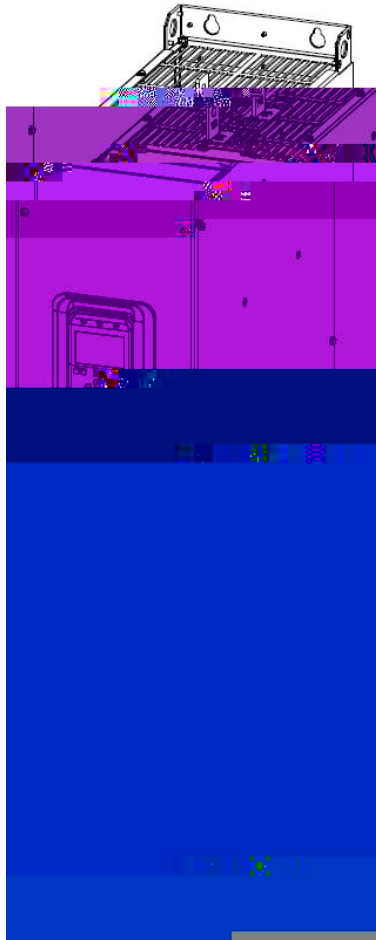



87! 87





%"

%" %

%" &

%" '

%" (

%" )



---

%

F78

F7A

F78

F7A

6

F78

F78

F78

F78

&

87! 87

&

**GUIDE**

kkk" [XYhYWVta

---

---

% &

f!%&

!

f!& &

87! 87

u s u B88Δ p#X+AMR+  
A

è

i 8Δ #

kkk" [XYhYWWVta

GUIDE



---

&" ( 87! 87

% 87! 87 #

#

&"

---

&" (" &

-)IF<

%\$\$\$

%\$\$\$

%\$\$

%

' \$\$\$



---

''

' "%

HF680N 09F — □□□ — 4

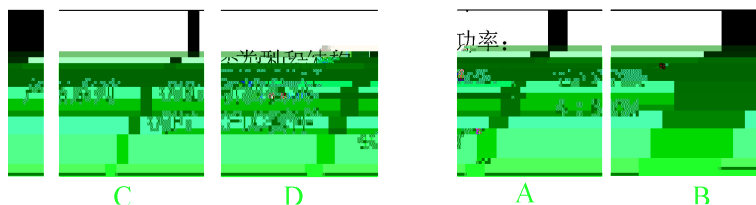

' "% %

5	*, \$B		
6	\$-A 87! 87	\$-:	87! 87
7	'		
8	(\$J		

' ! %

' "% &



' "% ' 87! 87

87! 87		J <sub>87</sub> J	f15k	f1_kk	J <sub>87</sub> fUk
< *, \$B\$-: ! %\$\$! (	< *, \$B\$-A! %\$\$! (	&) \$! +\$\$	% \$	%\$\$	) \$\$! +) \$
< *, \$B\$-: ! &\$\$! (	< *, \$B\$-A! &\$\$! (	&) \$! +\$\$	' \$ \$	&\$\$	) \$\$! +) \$
< *, \$B\$-: ! &*)! (	< *, \$B\$-A! &*)! (	&) \$! +\$\$	(\$ \$	&*)	) \$\$! +) \$
< *, \$B\$-: ! ' \$ \$! (	< *, \$B\$-A! ' \$ \$! (	&) \$! +\$\$	( ) \$	' \$ \$	) \$\$! +) \$
< *, \$B\$-: ! ( \$ \$! (	< *, \$B\$-A! ( \$ \$! (	&) \$! +\$\$	* \$ \$	(\$ \$	) \$\$! +) \$





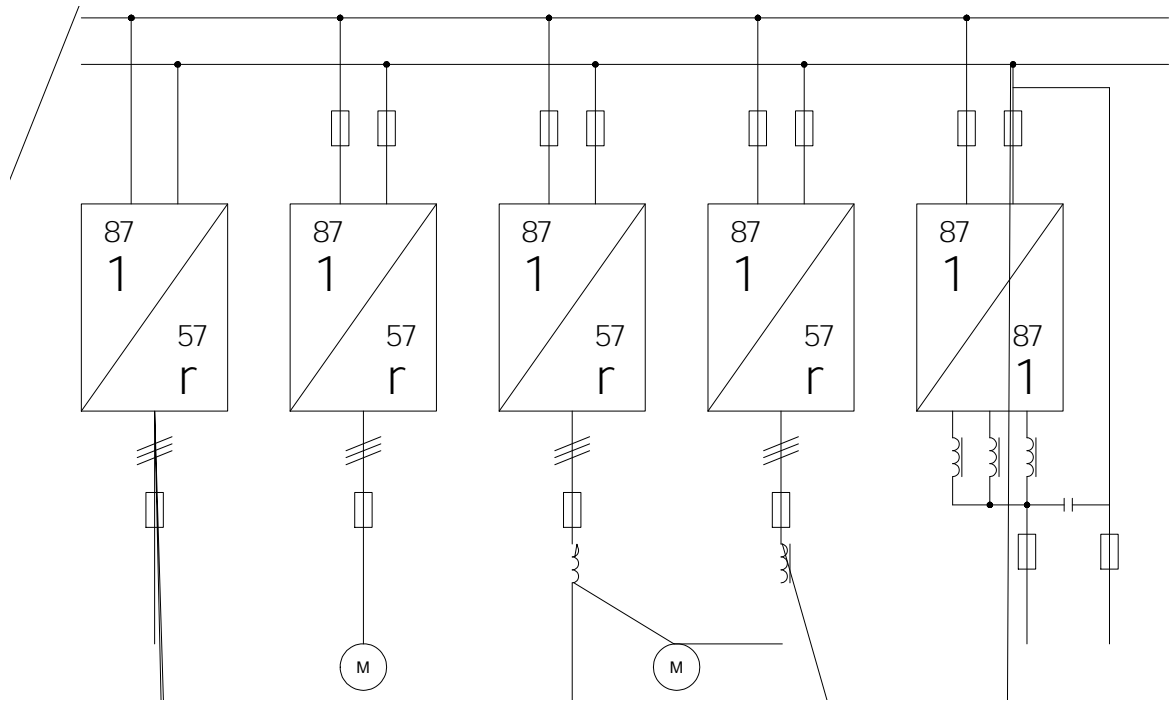

---

' "(

(" &" %

87! 87



' " (" (

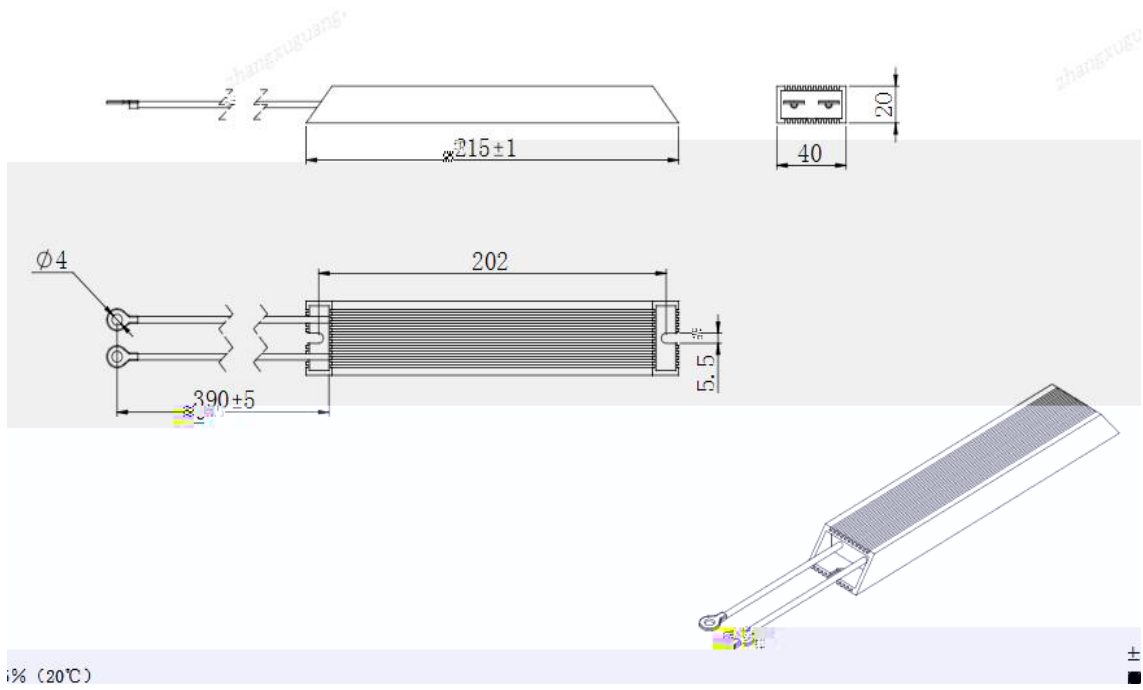

87! 87

< \*, \$B\$-: ! %\$\$! (

; 8< \*, \$B<7! %\$\$! , \$\$

---

("

("% 87! 87

!%\$

)Vá

\*

!%\$ Z(\$  
(\$

% %  
)\$

!&\$ Z\*\$  
% #

!&\$ Z\*\$

!%\$

+\$ %\$\* \_DU  
\$" + %" \$)

+\$ %\$\* \_DU  
\$" + %" \$)

\*\$ %\$\* \_DU  
\$" \* %" \$)

%\$<n Z )+<n  
)<n Z \*+<n

\$" \$+) aa



---

(" & &

%



kkk" [XYhYWVta

---



("&" (

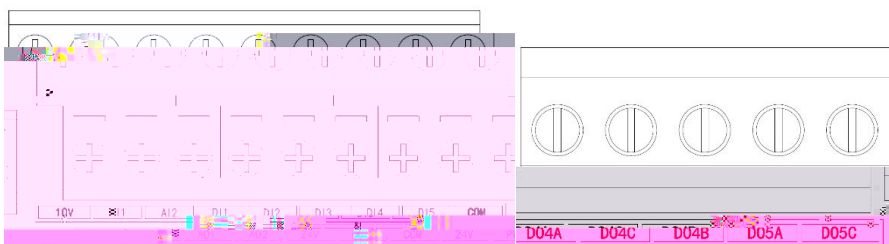
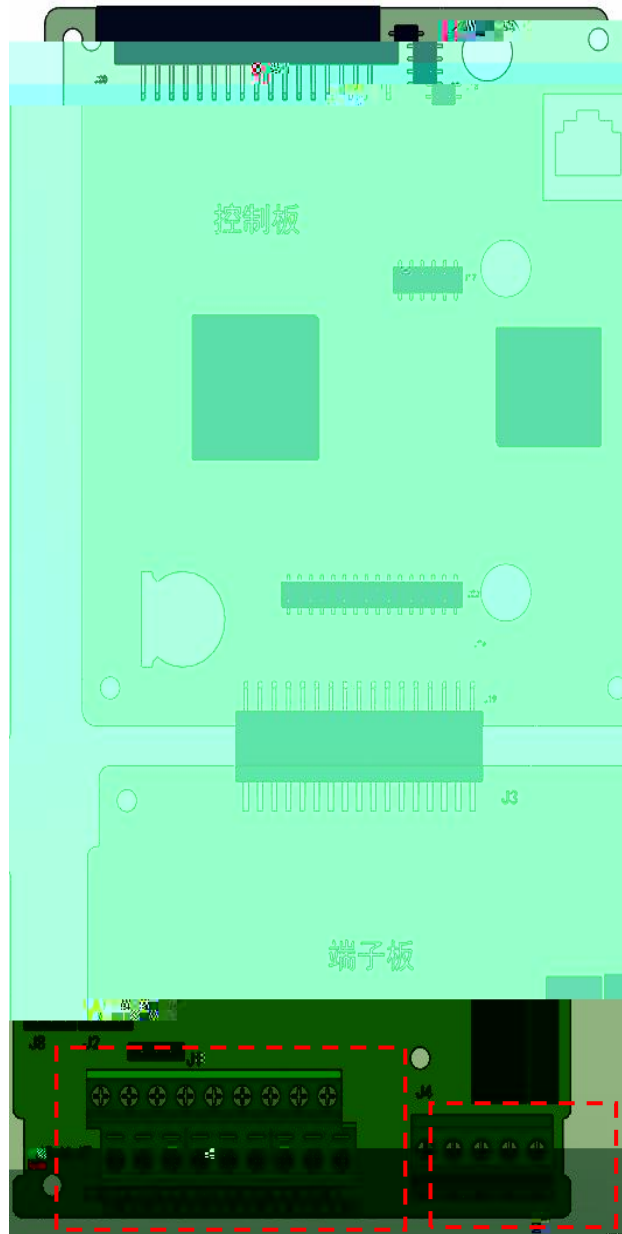

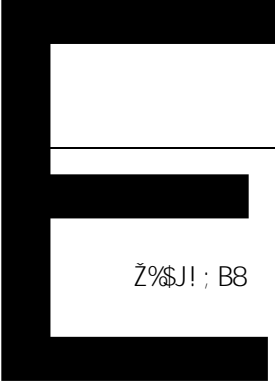

Ž%\$J! ; B8

%\$J

Ž%\$J

) \$a5

%\_» ! ) \_»

&(J

Ž&(J

&\$a5



DK

&(J

8=%f8=) 8C%

DK

&(J

---

87Ž&(J

("

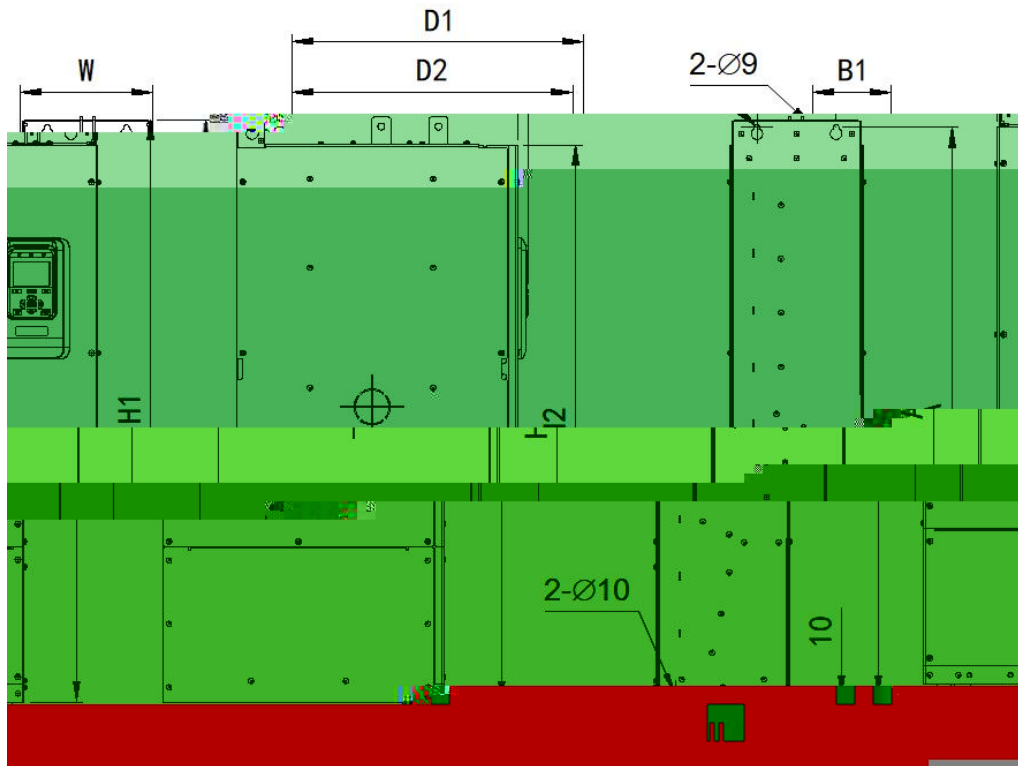

6(

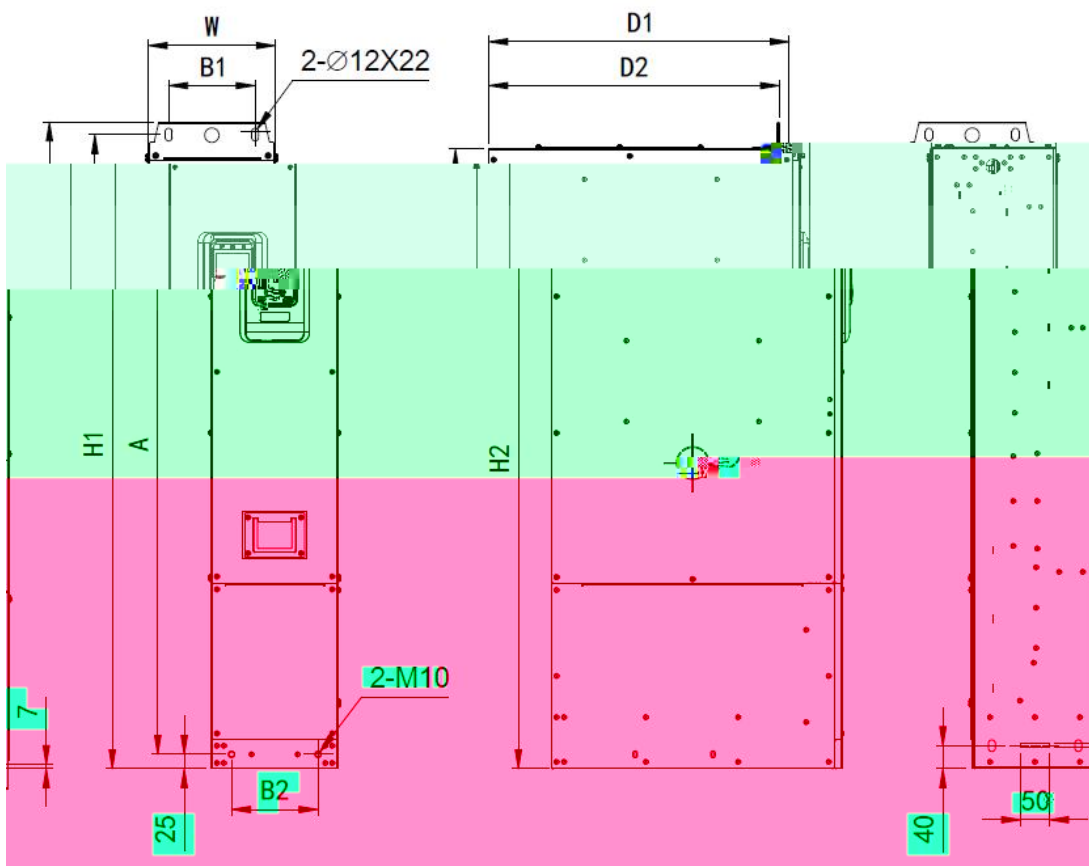

6)

		aa					aa			, ",	└┘
		<%	<&	K	8%	8&	5	6%	6&		
<: *, \$B\$- A! %\$\$! (	6(	- &\$	, , \$	&%\$	(*&	(((	, --	%&	%& \$	(! A,	))
<: *, \$B\$- A! &\$\$! (											
<: *, \$B\$- A! &*)! (											
<: *, \$B\$- A! ' \$\$! (											
<: *, \$B\$- A! ( \$\$! (	6)	%&&	%\$+)	&&%	)&&	)\$)	%\$+)	%& \$	%& \$	(! A%\$	, \$

)"

)"%

< \*, \$B\$-A 87! 87 : %  
@C75@#F9ACH9 : & FI B GHCD #F9G9H 9BH9F  
87! 87

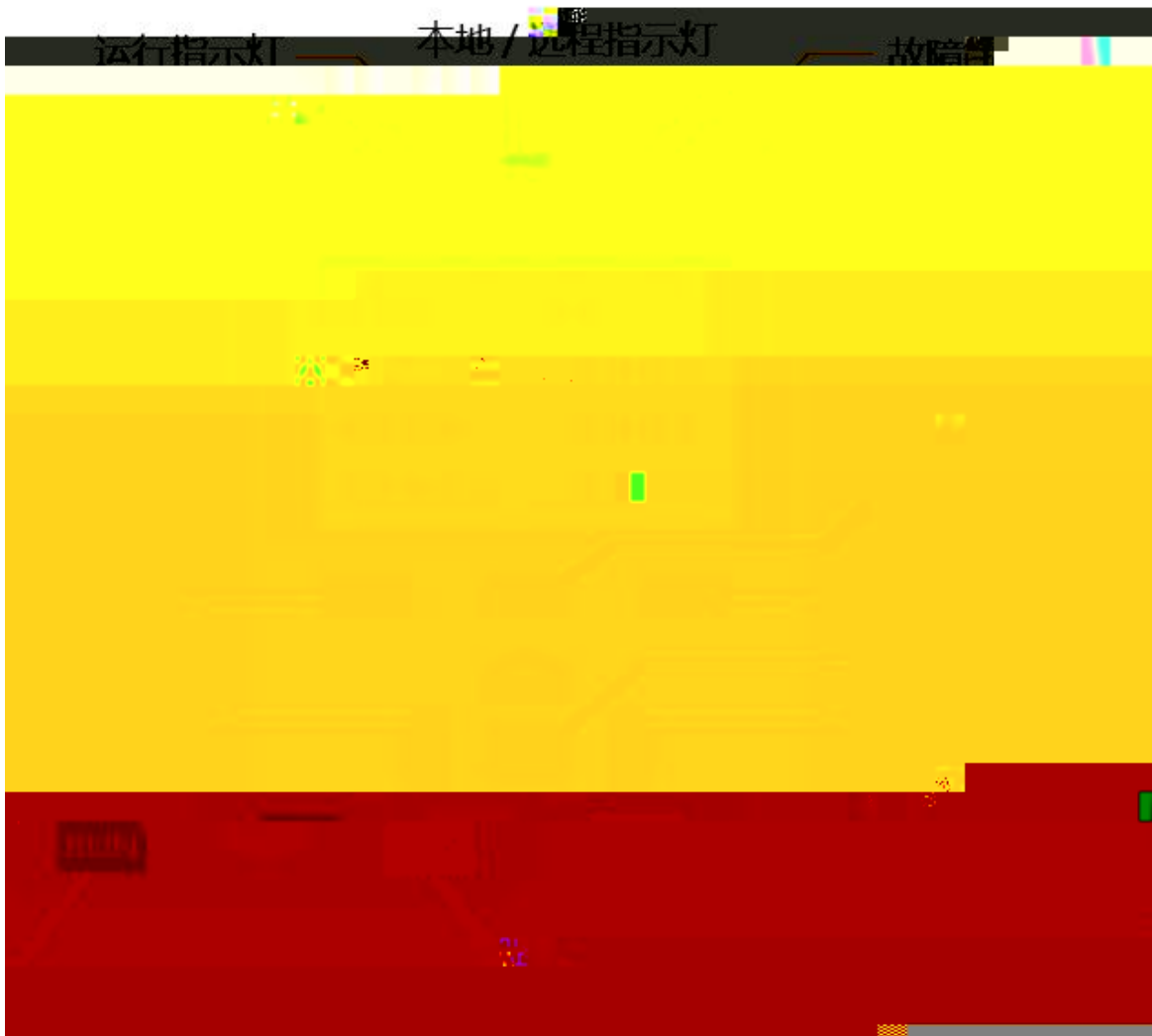

)"&

9BH9F

F I B G H C D

8787

@C75@#F9ACH9

#

)''

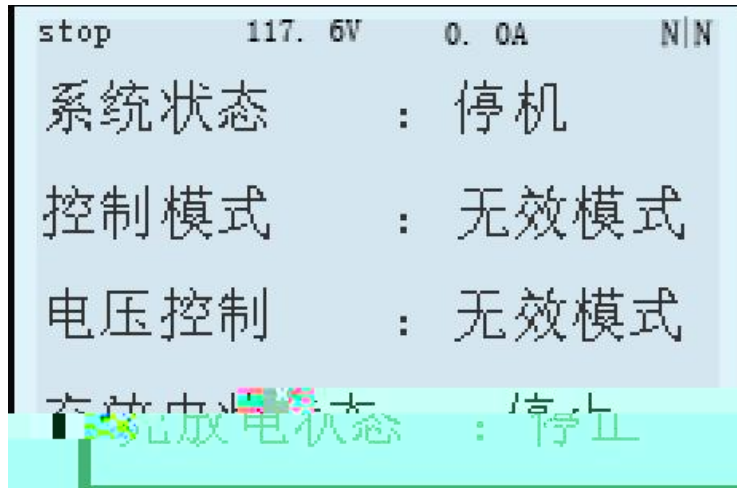

&

p

ghcd WXUF[Y  
8]gWXUF[Y

.J

5

p



---

+ Cdh] cb GYh

,

)	JYfg] cb	
*	8] gd Kcf_ H] aY	

)"("&

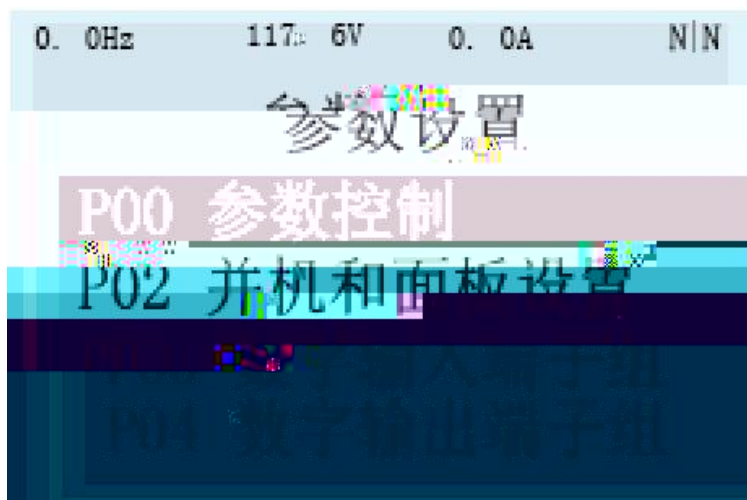

DUFUaYhYf GYhh] b[

)"("'

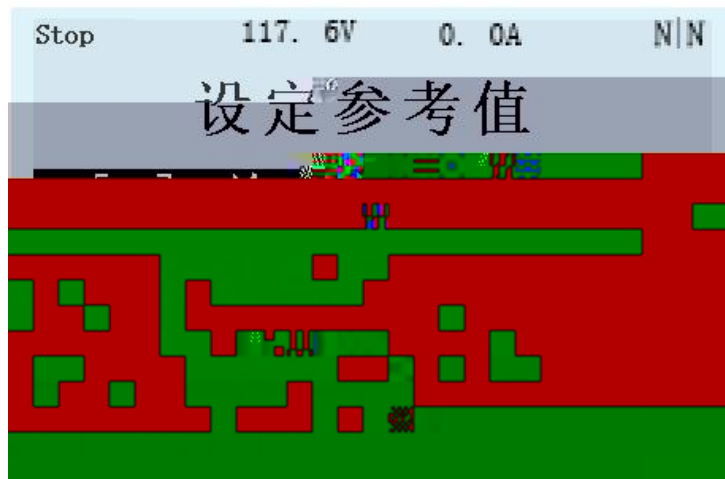

---

FYZYfYbW GYh

---

---

---

% DufUaYhYf  
=b] h] U ] nUh] cb

& 8Y` YhY : Ui ` h

, GmghYa FYghUf h

( 3 e e  
6UW\_i d DufU DUX

) FYghcfY DufU DUX  
8GD

\* 7cadUfY DufU DUX

+ 5Xa] b DUggkcf X j

9bhYf

)"(")

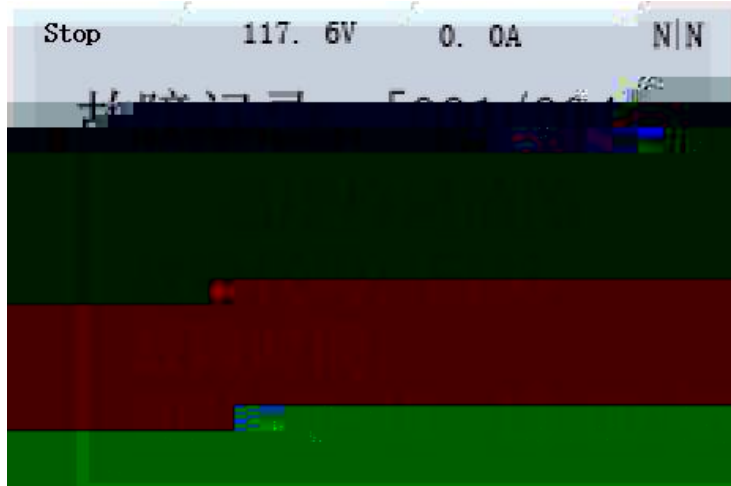

:Ui`h FYWcfX

)"("\*

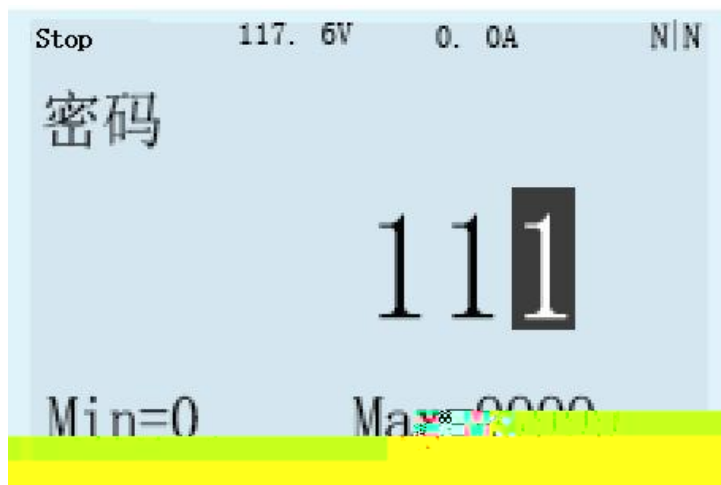

5WVgg DYfa] gg] cbg

---

\*"

\*" %"

8787

D\$- "\$'

8787

% 8787

&" 8787

\*" %" %

8787

ž

D- "\$'  
8787

O%Q

D- "\$('

O%Q

ž

ž

ž

ž

, \_\_\_\_\_

D- "\$'  
8787

O%Q

D- "\$('

O%Q

ž

ž

ž

ž

, \_\_\_\_\_

D- "\$'  
ž 8787

%

D- "\$('

ž

ž

ž

, \_\_\_\_\_



" | &  
 ? 1  $\frac{1}{2}$   
 D\$% \$ 1 ?

\*" &" &

" | %  
 " | &  
 ? 1  $\frac{1}{2}$   
 D\$% && 1 ?

\*" &" '

5 " =U%  
 5 " =U&  
 ?U 1  $\frac{1}{2}$   
 D\$% & 1 ?U

6 " =V%  
 6 " =V&  
 ?V 1  $\frac{1}{2}$   
 D\$%' 1 ?V

6 " =W%  
 6 " =W&  
 ?W 1  $\frac{1}{2}$

---

D\$% ( 1 ?W

\* " " "

8787

8787

\* " " "%



D+" \$\$

(\$\$J

Q, \$\$JQ

D+" \$%

\* \* \* \* \*

fl t

D+" %	fl t	fl t O&" \$gQ

\* \* \* \* +

D+" &%		O\$Q O%Q
D+" &'		O\$Q O%Q
D+" &(		O\$Q O%Q
D+" &)		O\$Q O%Q
D+" &*		O\$Q O%Q
D+" &+		O\$Q O%Q
D+" &,		O\$Q O%Q
D+" &-		O\$Q O%Q

+

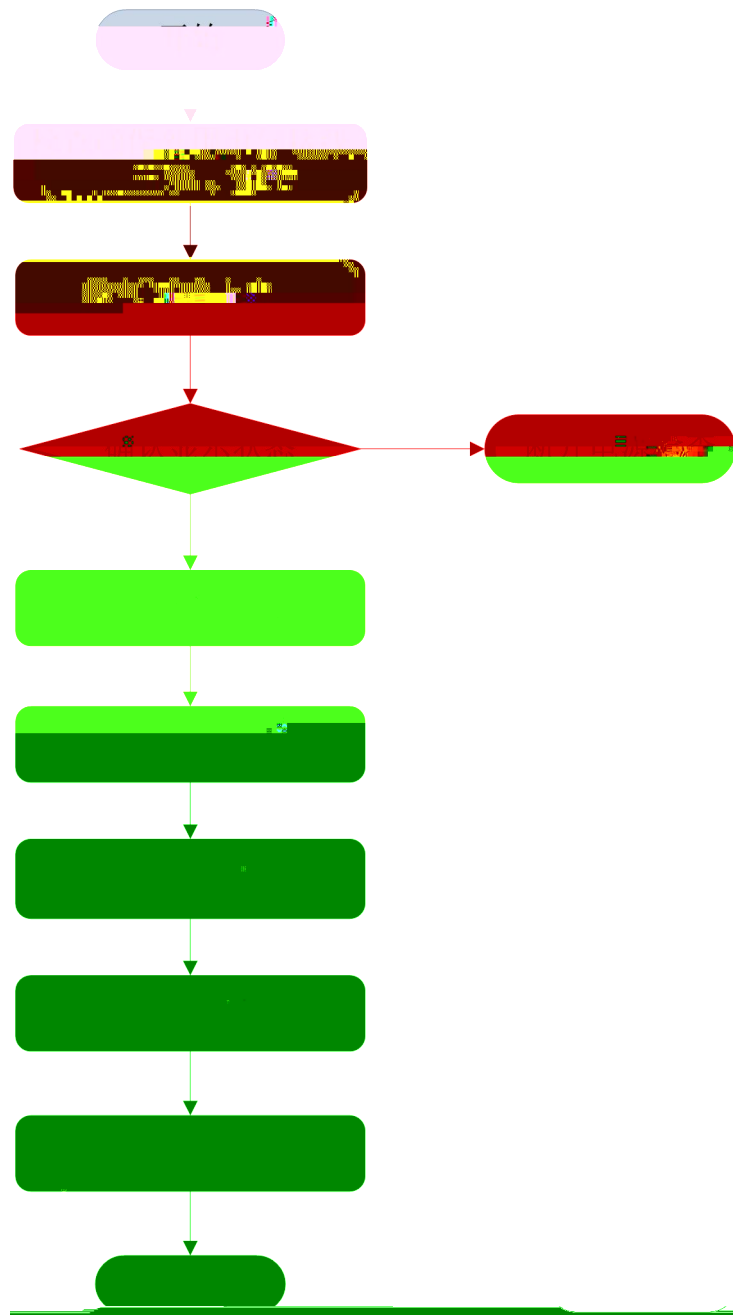

---

+ "%"

+ "&"

)" (" ( \_\_\_\_\_

ž

ž

+''"&

8787

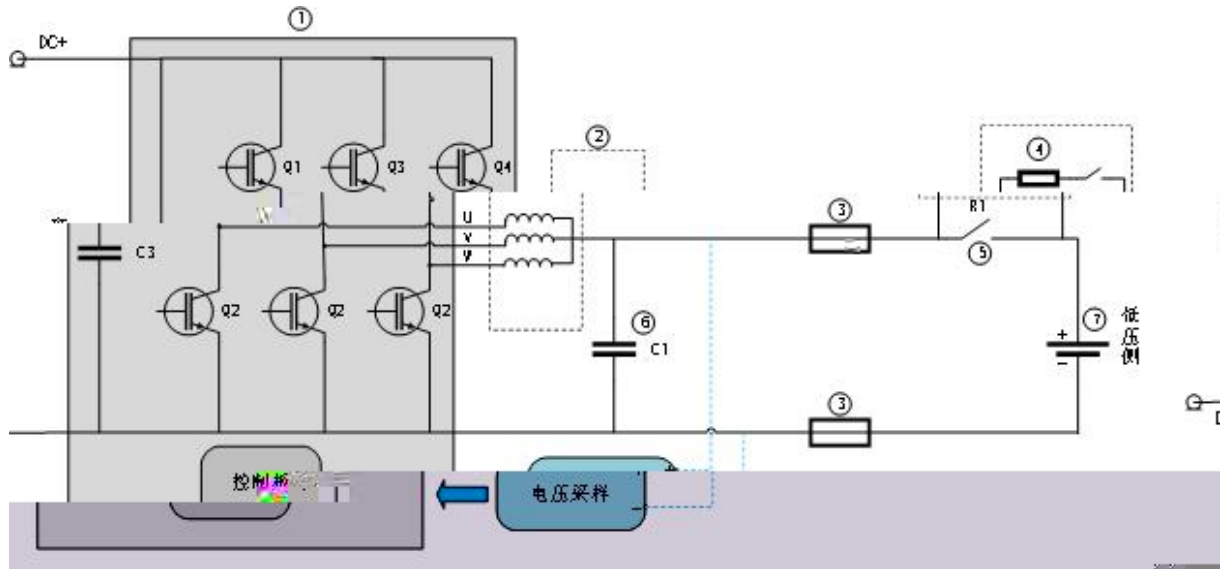

+("

+("%

D\$- "\$'

D\$- "\$(  
  
D\$- "\$'      D\$- "\$(  
  
(\$

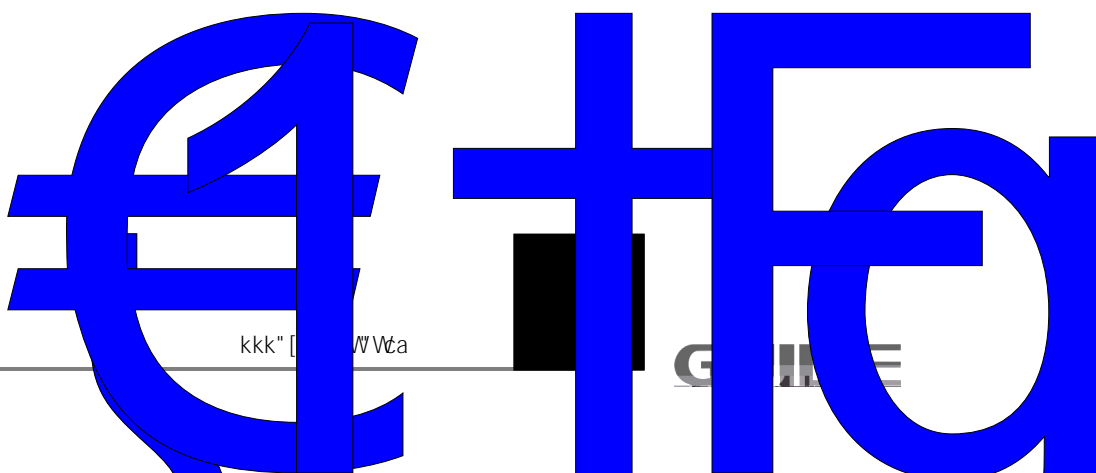
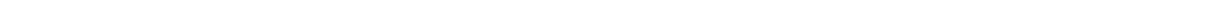

kkk" [ Wvta

G M E

---

\$

D\$-")%

D\$-")% \$ ž D\$- "&% 8W@j b\_

D\$-")&

D\$-")& \$ D\$- "&\* 8W@j b\_

D\$- "&\*

D, "\$(\$

D, "\$(\$ \$

)"("'  

---

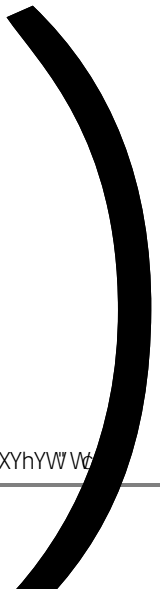

D\$- " ( \$

D\$- " ( \$ \$

&"

D\$- "' -

8787

D\$- "' -

D\$- "' \$ \$

' "

("

ž

+ "( (

D " \$	(	%\$ O	Q	
D " \$(	)	- O	Q	
D(" \$	(	, O	Q	
D(" \$(	)	+ O	Q	
D, " %*		%\$		!
D, " %+		&")		!
D+" %+		)"\$		!
D+" %		&"\$		!



		Q	
D- " \$'		% O Q	!
D- " \$(		% O Q	!
D ' " "\$	Df cZ] BYh	\$ %	%
D ' " "&%	OK(Q	% O \$Q	
D ' " "&'	OK) Q	% O JQ	

	%	\$	
6] h\$			
6] h%			!
6] h&			!
6] h'			!
6] h(			
6] h)			
6] h*	" 5		" 5
6] h+	" 6		" 6
6] h,	" 5		" 5
6] h-	" 6		" 6
6] h%\$			!
6] h%%			!
6] h%&			!
6] h%			!
6] h%(			!
6] h%&			!

	%	\$	
6] h\$			!
6] h%			!
6] h&			!
6] h'			!
6] h(!)			\$\$\$fi \$%fi %\$fi
6] h*! +			\$\$\$fi \$%fi %\$fi %&fi
6] h, ! -			\$\$\$fi \$%fi %\$fi %&fi
6] h%\$			!
6] h%%			!
6] h%&			% \$

6] h% ! %			\$\$\$fi \$\$%fi \$%\$fi \$%8fi %\$ \$fi %\$%fi %\$ \$fi %88fi	D6
-----------	--	--	---	----

OK(Q V] h\$ 1% 8787 V] h\$1\$ 8787  
OK)Q \$! %\$\$\$ \$ %\$\$\$

+)"( AcXVI g

AcXVI g

D, " \$\$		' QAC86I GQ	!
D, " \$%		% O Q	!
D, " \$&		% O Q	!
D, " '\$		% O Q	!
D, " \$(		' QAcXVI g Q	!
D- " '\$		% O Q	!
D- " \$(		% O Q	!

AcXVI g

	%	\$	
6] h\$			
6] h%			!
6] h&	@C75@	F9ACH9	
6] h'	: 5I @HSF9G9H		!
6] h(	9LHS: 5I @H		
6] h)	9LHS5@5FA		
6] h*	7hf` AcXY" 5		" 5
6] h+	7hf` AcXY" 6		" 6
6] h,	Jc` h7hf` HrdY" 5		" 5

---

6] h\$      FYUXm  
6] h%      F1 B              Ghc

---

% \$% 5XXfYgg 1 % \$%

---

, "

, "%"

, "%" %

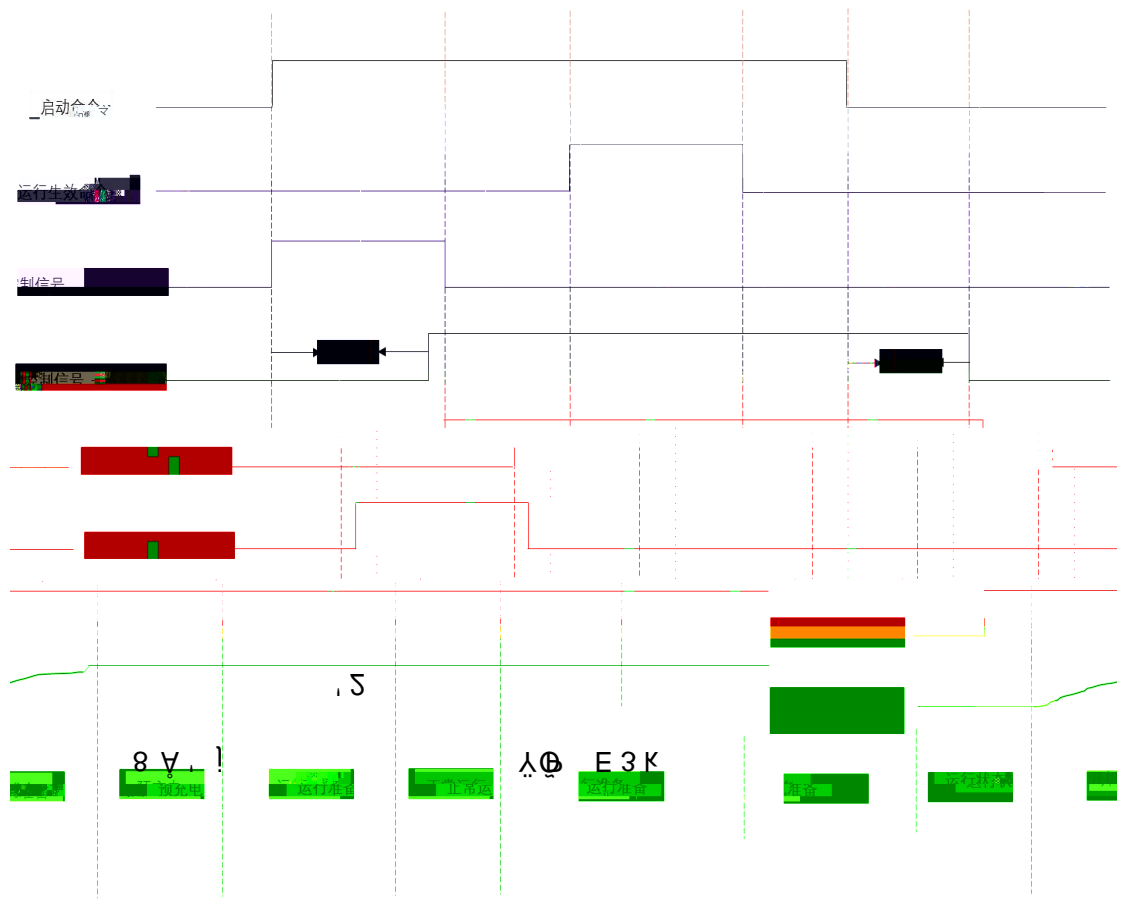

- 1> D+"%+ ) D+"%
- & #
- 2> D+"% D+"%
- & #
- 3> 8C( 8=(
- 4> 8C) 8=)
- 5> W

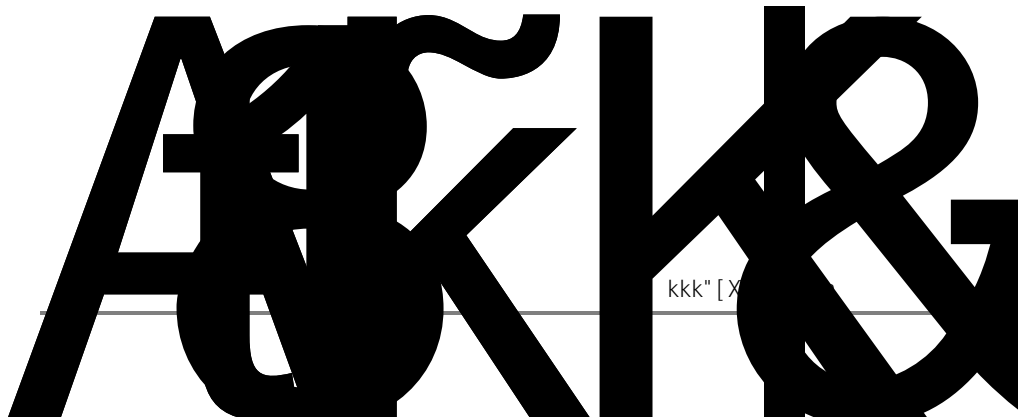

6] h*	" 5		" 5
6] h+	" 6		" 6
6] h,	" 5		" 5
6] h-	" 6		" 6
6] h%\$			!
6] h%%			!
6] h%&			!
6] h%			!
6] h%(			!
6] h%)			!

, " % '

	%	\$	
6] h\$			!
6] h%			!
6] h&			!
6] h'			!
6] h(!)			\$\$fi
			\$\$fi
			%%fi
6] h*! +			\$\$fi
			\$\$fi
			%%fi
			%%fi
6] h, ! -			\$\$fi
			\$\$fi
			%%fi
			%%fi
6] h%\$			!
6] h%%			!
6] h%&		a"	

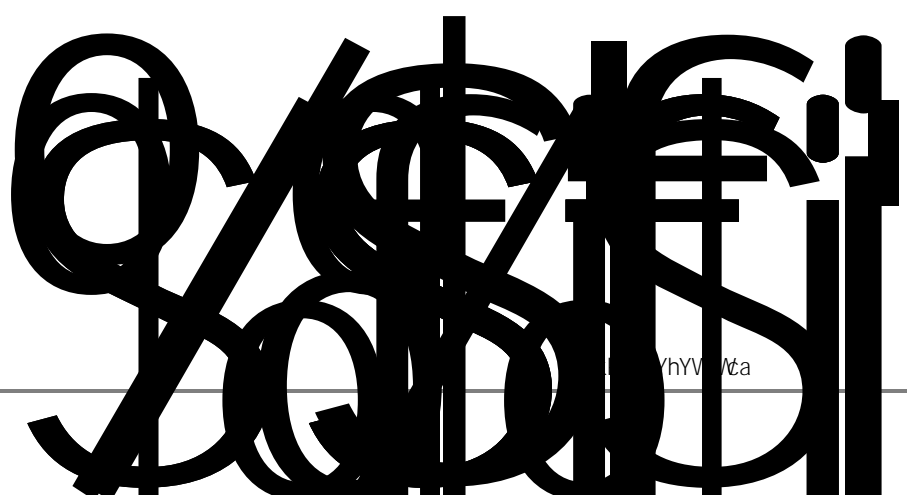

, " % (

V] h% ! %		
\$\$\$fIG%&		G&
\$\$%fIG&&		G
%&%fIG 7		G( "
%&%fIG( 7		G*
\$\$%fIG) 7		G)
\$\$%fIG* 7		G& G+
\$\$\$fIG+7		G&
%&%fIG, 7	D6	DB G, G&

, " &"

, " &" %

D%\$" \$\$

D, " %		O\$Q=C O%Q O&QAcXVi g O Q&d
D, " &		O\$Q=C O%Q O&QAcXVi g O Q&d
D- " \$'		O\$Q O%Q O&Q O Q
D- " \$(		O\$Q O%Q O&Q O Q
D- " \$\$		

)&

		fl t
D, " \$(		O\$Q O%Q5=% O&Q5=& O QAcXVi g O( Q8d
D, " \$,		ž / )" \$! #gž

D, " \$( \$

)" ("'

D, " \$%		O\$Q=C <del>O%Q</del> O&QAcXVi g O Q8d
D, " \$&		O\$Q=C <del>O%Q</del> O&QAcXVi g O Q8d
D- " \$'		O\$Q <del>O%Q</del> O&Q O Q
D- " \$(		O\$Q <del>O%Q</del> <del>O&amp;Q</del> O Q
D- " \$\$		fl t
D, " \$,		ž / )" \$! #gž
D- " &%	8W @] b_	
D- " &*	8W @] b_	
D- " )%		\$. % AcXVi g & 8d
D- " )&		\$. % AcXVi g & 8d



		O%Q O&Q O Q
D- " \$%		ž
D, " \$(		O\$Q O%Q5=% O&Q5=& O QAcXVi g O( Q8d
D, " \$*		\$. D, " \$( %
D, " \$-		/ / )" \$! #gž

D, " \$( O, \$ ( L\$ s..

)" (" /

5

D, " \$\*

\$

D, " \$(

%

, " " %

, " & "



D, " \$%

Σ

BOVA

HOZAVI ā

**MI**

**\$ \$ %**

Σ s..

e &

kkk" [XYhV Wta

**GUIDE**

))

---

		Q( Q8d
D, " \$-		/ / )" \$! #gž

D, " \$( \$  
)" (" /



---

D, "%& 1&

D, "%& 1'

, \$l

, " " "

, " " "%

8787

8787



, " (% AcXVi g

AcXVi g

D' &" \$%	AC86I G =8	A] b1% AUI 1&)) %
D' &" \$&	AC86I G	O\$Q FG(, ) / O%Q FG&' & FG(, )
D' &" \$'	AC86I G	O\$Q - *\$\$ 6DG O%Q %( (\$\$ 6DG O&Q % &\$ \$ 6DG O Q ' , ( \$\$ 6DG O( Q ) *\$\$ \$ 6DG O) Q ) +*\$\$ 6DG O*Q %& \$ \$ 6DG
D' &" (		O\$Q BcbYS, S%\$7: ; O%Q gY YbS, S%\$7: ; O&Q CXXS, S%\$7: ; O Q BcbYS, S&\$7: ; O( Q gY YbS, S&\$7: ; O) Q CXXS, S&\$7: ;
I G		AC86

AcXVi g

\$) <

acXVi g %\$			F#K
\$		\$. %	K
%			!
&		%	K
'		%	K
(		\$ %	K
)		\$ %	K
*	" 5	\$\$.	K
+	" 6	\$\$ %\$.	K

\*\$

		%%	
,	" 5	\$. \$%	K
-	" 6	%. %%	K
! %			!

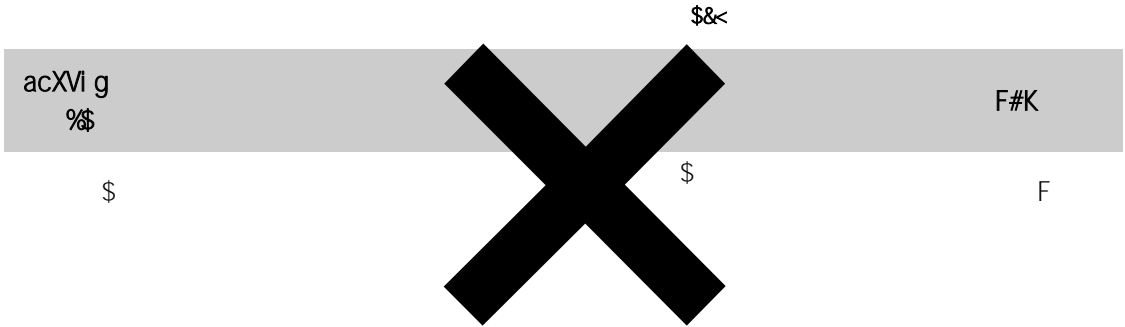

7

-

æ

" i

acXVI g %\$				F#K
\$	8=		8=	F
)\$		%QJO	%%\$ 12 % \$QJOž !%\$ r Ž%\$QJO	F
)%		%O=O	%%\$ 12 %Qa5Qž \$ r &\$Qa5Q	F
)&		&QJO	%%\$ 12 % \$QJOž !%\$ r Ž%\$QJO	F
)'		&O=O		

%&	6		%\$12%" \$5	F
%	7		%\$12%" \$5	F
%+			%\$12%" \$J	F
%			%\$12%" \$J	F
%			%\$12%" \$	F
&%		I	%\$12%" \$I	F
&&		I	%\$12%" \$I	F
&		I	%\$12%" \$I	F
) \$	5C%	%	%\$ 12 %" \$Q Q	F#K
) %	5C&	&	%\$ 12 %" \$Q Q	F#K
* \$			O\$+" "\$ \$Q . O% " " \$, Q .	F
* &			O\$+" "\$ \$Q . O% " " \$, Q .	F
%\$\$		O\$" % Q	%\$ 12 %" \$I	F#K
%\$%		\$" %Q	%\$ 12%" \$J	F#K
%\$&		\$" %	%\$ 12%" \$I	F#K
%\$'		\$" %	%\$ 12%" \$5	F#K
%\$(:		\$" %		F#K
%\$)				

---

, " (" & DB

8787 DB DB " DB ž  
DB 8787



---

			%\$%fi %\$%fi %\$%fi D6
--	--	--	-------------------------------

8787

8787

8787

---

- "

- "%

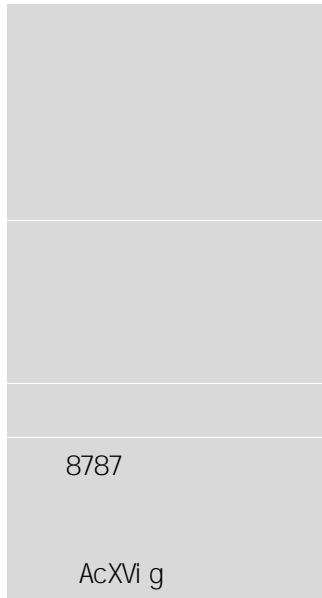

D\$

D&

D'

D(

D)

D\*

D+

D,

D- 8787

D%\$

D' & AcXVi g

%		
'	" U	% \$ \$\$
(	" V	\$\$ %\$ %%
)	" U	% \$ \$\$
*	" V	\$\$ %\$ %%
+		
,		
-		
%\$		
%%		
%&	" B7	
%	: I B7 %&	
%{	: I B7 %	
%}	: I B7 %{	
%*	: I B7 %}	

- " & "

D(

D( " \$	%		\$ %}	\$
D( " %	&		\$ %}	\$
D( " &	'		\$ %}	\$
D( " "	(		\$ %}	\$
D( " (	)		\$ %}	\$

\$		
%		
&		CB
'		



D) " *	5=%	5=%	! '\$\$ \$ ' '\$\$ \$ Q Q	\$" \$ Q Q
D) " +	5=%	5=%	! %\$ "\$ \$ %\$ "\$ \$ Q Q	%\$ "\$\$\$ Q Q
D) " ,	5=%	5=%	\$" "\$ \$ &\$ "\$ \$ Qa5Q	&\$ "\$\$\$ Qa5Q
D) " -	5=%	5=%	! '\$\$ \$ ' '\$\$ \$ Q Q	%\$\$ "\$ \$ Q Q
D) " %	5=&	O\$Q O%Q\$ Z%\$J O&Q %\$ Z%\$J O Q\$ &\$a5	\$ '	'
D) " %	5=&	5=&	\$" \$ %\$\$\$\$ "\$ \$ QagQ	&)" \$ QagQ
D) " &\$	5=&	5=&	! %\$ "\$ \$ %\$ "\$ \$ Q Q	\$" \$\$\$ Q Q
D) " &%	5=&	5=&	! &\$ "\$ \$ &\$ "\$ \$ Qa5Q	\$" \$\$\$ Qa5Q
D) " &&	5=&	5=&	! %\$ "\$ \$ %\$ "\$ \$ Q Q	\$" \$\$\$ Q Q
D) " &'	5=&	5=&	\$" "\$ \$ &\$ "\$ \$ Qa5Q	\$" \$\$\$ Qa5Q
D) " &(	5=&	5=&	! '\$\$ \$ ' '\$\$ \$ Q Q	\$" \$ Q Q
D) " &)	5=&	5=&	! %\$ "\$ \$ %\$ "\$ \$ Q Q	%\$ "\$\$\$ Q Q
D) " &*	5=&	5=&	\$" "\$ \$ &\$ "\$ \$ Qa5Q	&\$ "\$\$\$ Qa5Q
D) " &+	5=&	5=&	! '\$\$ \$ ' '\$\$ \$ Q Q	%\$\$ "\$ \$ Q Q

---

- "&" ( Ê e

D*" &%	5C&	5C& fID*" % O% Q t	" \$ %\$\$\$ \$ O Q	" \$ O Q
D*" &&	5C&	5C%	" \$ %\$\$\$ \$ OagQ	" \$ OagQ

+! %

\$		
%		
&		
,		fl t
(		fl % \$ t
)	8D	Df cZ] Vi g
*		D*" + D*" &%
+		

- " &")

D+



D+" \$\$ \*\$\$ , &\$ , \$\$  
OQ OQ

D+" %\$ ' \$\$ )\$\$ ' )\$  
OQ OQ

D+" \$& "





- "&" \*

D,

D, " \$\$		O\$Q O%Q O&O8d O QAC86l G O(Q	\$ (	%
D, " \$%		O\$Q=C O%Q O&OAcXVI g O Q8d	\$ '	%
D, " \$\$		O\$Q=C O%Q O&OAcXVI g O Q8d	\$ '	%
D, " \$'		O\$Q fl t O%Q	\$ %	%
D, " \$(		O\$Q O%Q5=% O&Q5=& O QAcXVI g O(Q8d	\$ (	\$
D, " \$*		\$. D, " \$( %	\$ %	\$
D, " \$,			\$" \$ ' \$\$\$ \$ Q #gQ	)" \$ Q #gQ
D, " \$-			\$" \$ ' \$\$\$ \$ Q #gQ	)" \$ Q #gQ
D, " %%		O\$Q O%Q	\$ %	%
D, " %&		O\$Q O%Q O&Q O Q , \$l	\$ '	'
D, " %		D, " %&1% D, " %	\$ ' \$\$ Q Q	-\$ Q Q
D, " %<			\$" \$% )" \$\$\$ OgQ	\$" % OgQ
D, " %>			\$" \$% )" \$\$\$ OgQ	\$") OgQ
D, " %*			\$" % * \$\$\$ \$ OgQ	% OgQ
D, " %+			\$" % %\$ \$ OgQ	&") OgQ







		% 9j YbS, S%\$7: ; & CXXS, S%\$7: ; ' BcbYS, S&\$7: ; (. 9j YbS, S&\$7: ; ) . CXXS, S&\$7: ;		
D' &" \$)			\$ž %\$\$ OgQ	\$ OgQ

- " &" %\$

D ' '

D' '\$	Df cZ] Vi g	O\$Q O%Q	\$ %	\$
D' "%		D@7	% &)	%
D' "&		O\$ODDC % O%ODDC & O&ODDC ) O Q I =89	\$ '	&
D' '''			\$ %*	%
D' "(			\$ %*	%
D' ")		O\$Q O%Q O&Q O Q		

		O(Oy %\$\$\$\$			
D' '"%+	OK&Q	+! &	\$ ' ,		\$
		O\$OyC% ž a" S	c		%
		O%Oy %\$ a" R			
D' '"%	OK&Q	O&Oy %\$\$	\$ (		\$
		O' Oy\$\$\$\$z a" X			
		O(Oy\$\$\$\$\$ c	\$		

D' '"%	OK' Q	+! &	\$ ' ,		\$
		O\$Oy %			
		O%Oy %\$			
D' '"&\$	OK' Q	O&Oy %\$\$	\$ (		\$
		O' Oy %\$\$\$			
		O(Oy %\$\$\$\$			

D' '"&%	OK(Q	+! &	\$ ' ,		%
		SSOy %			
		O%Oy %\$			
D' '"&&	OK(Q	ESOy %\$\$\$	\$ " %		\$
		WOOy %\$\$\$			
		WOOy %\$\$\$\$			

E, " % D' '"&	OK(Q	+! &	\$ ' ,		%
------------------	------	------	--------	--	---

EO, % % D' '"%	EL,	( %	€	Σ	g..	€	g	Σ	..	€9
		WOO W\$\$\$								
	dG K	W\$	CC		... %	€				
		†	"		\$					
		eO zO	C							%
		, g								

	H O	W\$\$\$	C		\$
--	-----	---------	---	--	----

		i g			
		W\$\$\$			
		€			
		xOO Σ g..	C'		CC

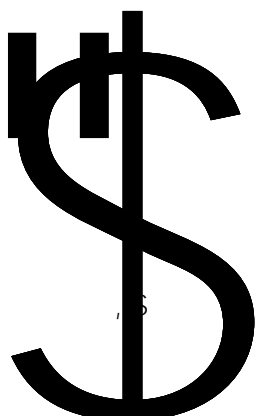



		$O&Qy \text{ } \%\$$ $O \ Qy \ \%\$\$\$$ $O(Qy \ \%\$\$\$\$)$		
$D' \ ' \ ' \ ( )$	$OK\$Q$	$+! \ ' \ '$	$\$ \ ( ,$	$\$$
$D' \ ' \ ' \ ( * )$	$OK\$Q$	$O\$Qy \ \%$ $O\%Qy \ \%\$$ $O&Qy \ \%\$\$$ $O \ Qy \ \%\$\$\$$ $O(Qy \ \%\$\$\$\$)$ $O) \ \infty \ Qy \ \%$ $O^* \ \infty \ Qy \ \%\$$ $O+ \ \infty \ Qy \ \%\$\$$	$\$ \ +$	$\$$
$D' \ ' \ ' \ ( + )$	$OK\%Q$	$+! \ ' \ '$	$\$ \ ( ,$	$\$$
$D' \ ' \ ' \ ( , )$	$OK\%Q$	$O\$Qy \ \%$ $O\%Qy \ \%\$$ $O&Qy \ \%\$\$$ $O \ Qy \ \%\$\$\$$ $O(Qy \ \%\$\$\$\$)$ $O) \ \infty \ Qy \ \%$ $O^* \ \infty \ Qy \ \%\$$ $O+ \ \infty \ Qy \ \%\$\$$	$\$ \ +$	$\$$
$D' \ ' \ ' \ ( - )$	$OK&Q$	$+! \ ' \ '$	$\$ \ ( ,$	$\$$
$D' \ ' \ ' \ ( ) \$$	$OK&Q$	$O\$Qy \ \%$ $O\%Qy \ \%\$$ $O&Qy \ \%\$\$$ $O \ Qy \ \%\$\$\$$ $O(Qy \ \%\$\$\$\$)$ $O) \ \infty \ Qy \ \%$ $O^* \ \infty \ Qy \ \%\$$ $O+ \ \infty \ Qy \ \%\$\$$	$\$ \ +$	$\$$
$D' \ ' \ ' \ ( ) \%$	$OK' \ Q$	$+! \ ' \ '$	$\$ \ ( ,$	$\$$
$D' \ ' \ ' \ ( ) \&$	$OK' \ Q$	$O\$Qy \ \%$ $O\%Qy \ \%\$$ $O&Qy \ \%\$\$$ $O \ Qy \ \%\$\$\$$ $O(Qy \ \%\$\$\$\$)$ $O) \ \infty \ Qy \ \%$ $O^* \ \infty \ Qy \ \%\$$ $O+ \ \infty \ Qy \ \%\$\$$	$\$ \ +$	$\$$
$D' \ ' \ ' \ ( ) \ ' \ '$	$OK(Q$	$+! \ ' \ '$	$\$ \ ( ,$	$\%$
$D' \ ' \ ' \ ( ) \ ($		$O\$Qy \ \%$ $O\%Qy \ \%\$$	$\$ \ +$	$\$$



---

D' " " \*'

OK-Q

+!'

\$ (,

%

OSQy %

D' " " \*'(

OK-Q



&&	0?kQ
&	Q Q
&(	05Q
&)	05Q
&*	05Q
&+	%Q Q
&	&Q Q
&-	Q Q
' \$	Q Q
' %	Q]Q
' &	Q]Q
' '	Q]Q
' ('	Q]Q
' )	%Q]Q
' *	&Q]Q
' +	%Q]Q
' ,	&Q]Q

+!'

\$	
%	\$
&	%
'	&
(	'
)	(
*	)
+	\$ ' &]h
,	% ' &]h
-	& ' &]h
;%	' ' &]h
%%	( ' &]h
%&	) ' &]h
% ! %*	
%+	
%	
%	
&\$	
&%	5
&&	
&	?k
&(	5
&)	6
&*	7
&+	5



---

%\$"

%\$ %

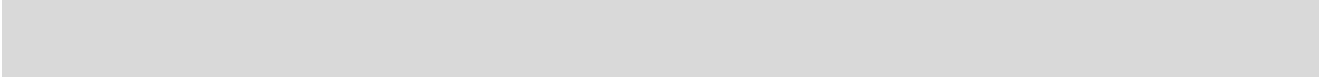

K\$%

GM&SBCHSF8M fIFYUXmt

K&)	) G@) S75BS9FF	)	)

%\$" &



09\$) \$Q I =; 6H  
 9FFSI H bch fYgYh =; 6H

09\$) &Q J =; 6H  
 9FFSI H bch fYgYh =; 6H

09\$) (Q K =; 6H  
 9FFSI H bch fYgYh =; 6H

09\$\*) Q 8C  
 8C  
 8787 8C  
 8787 8=



09\$\*\*Q 8C  
 8C  
 8787



---

09&&\$Q	7F7 A9ACFM 7F7 9FF	
09&&%Q	D5F5A9H9F 9FFCF	

---

%\$'



87&(J

8C

8C

8C

CB

7CA

CB

7CA

---

%%'

%'

---

%&

	% &	% 2 (\$ 0 -) I &
	% &	% &
	% & ' "	% & ' "
	% &	% &

%'

87! 87

		% &
D76	&	







# GUIDE

% 87! 87

&

,

Ki \Ub ; i ] XY HYW\bc` c[ m 7c" ž@hX"

\*

(' \$&&'

, \*! \$&+! , +- &+&' \$

g\Zk4[ XYhYW\Wca

kkk" [ XYhYW\Wca

( \$\$! \$\$+++! ) +\$